

STANDARD EQUIPMENT

ISO Standard cabin
 All-weather steel cab with 360° visibility
 Safety glass windows
 Rise-up type windshield wiper
 Sliding fold-in front window
 Sliding side window(LH)
 Lockable door
 Hot & cool box
 Storage compartment & Ashtray
 Cabin roof-steel cover
 Radio & USB player
 12 volt power outlet (24V DC to 12V DC converter)
 Computer aided power optimization (New CAPO) system
 3-power mode, 2-work mode, user mode
 Auto deceleration & one-touch deceleration system
 Auto warm-up system
 Auto overheat prevention system
 Automatic climate control
 Air conditioner & heater
 Defroster
 Self-diagnostics system
 Starting Aid (air grid heater) for cold weather
 Centralized monitoring
 LCD display
 Engine speed or Trip meter/Accel.
 Clock
 Gauges
 Fuel level gauge
 Engine coolant temperature gauge
 Hyd. oil temperature gauge
 Warnings
 Check engine
 Communication error
 Low battery
 Air cleaner clogging
 Indicators
 Max power
 Low speed/High speed
 Fuel warmer
 Auto idle
 Door and cab locks, one key
 Two outside rearview mirrors
 Fully adjustable suspension seat with seat belt
 Pilot-operated slidable joystick
 Four front working lights
 Electric horn
 Batteries (2 x 12V x100 AH)
 Battery master switch
 Removable clean-out screen for oil cooler
 Automatic swing brake
 Removable reservoir tank
 Fuel pre-filter with fuel warmer
 Boom holding system
 Arm holding system
 Accumulator for lowering work equipment
 Electric transducer
 Lower frame under cover (Normal)
 Tires-dual (9.00-20-14PR)
 Travel alarm
 Rear dozer blade

OPTIONAL EQUIPMENT

Fuel filler pump (35 L/min)
 Beacon lamp
 Single-acting piping kit (breaker, etc.)
 Double-acting piping kit (clamshell, etc.)
 Quick coupler
 Travel alarm
 Booms
 4.6m, 15' 1"
 Arms
 1.9m, 6' 3"
 2.1m, 6' 11"
 2.5m, 8' 2"
 3.0m, 9' 10"
 Cabin FOPS / FOG (ISO / DIS 10262 Level II)
 FOPS (Falling Object Protective Structure)
 FOG (Falling Object Guard)
 Cabin guard-Front
 Wire net
 Fine net
 Cabin lights
 Cabin front window rain guard
 Sun visor
 Undercarriage
 Rear outrigger
 Rear dozer and front outrigger
 Rear and front outrigger
 Rear outrigger and front dozer
 Lower frame under cover (Additional)
 Pre-heating system, coolant
 Tool kit
 Operator suit
 Rearview camera
 Seat
 Mechanical suspension seat with heater
 Tires - dual (9.00 - 20 solid)
 Fenders (Mudguards)
 Hi-mate (Remote Management System)
 Air compressor
 Precleaner
 Rear work lamp

* Standard and optional equipment may vary. Contact your Hyundai dealer for more information. The machine may vary according to International standards.
 * The photos may include attachments and optional equipment that are not available in your area.
 * Materials and specifications are subject to change without advance notice.
 * All imperial measurements rounded off to the nearest pound or inch.

PLEASE CONTACT

 **HYUNDAI CONSTRUCTION EQUIPMENT**

MOVING YOU FURTHER

Robex
140w-95

With Tier 2 Engine installed



*Photo may include optional equipment.

Pride at Work

Hyundai Construction Equipment strives to build state-of-the-art earthmoving equipment to give every operator maximum performance, more precision, versatile machine preferences, and proven quality. Take pride in your work with Hyundai!

Robex 140w-95

Machine Walk-Around

Engine Technology

Proven / reliable, fuel efficient Cummins Tier II B3.9-C engine
Low noise / Auto engine warm up feature / Anti-restart feature

Hydraulic System Improvements

New patented hydraulic control system for improved controllability / Improved control valve design for added efficiency and smoother operation / New auto boom and swing priority system for optimum speed / New auto power boost feature for additional power when needed / Improved arm-in flow regeneration system for added speed and efficiency

Pump Compartment

Industry-leading, powerful, reliable Kawasaki designed, variable volume in-line axial piston pumps
New compact solenoid block equipped with 3 solenoid valves, 1 EPPR valve, 1 check valve accumulator and pilot filter-controls safety lock, power boost, arm-in regeneration control, boom priority (swing logic valve control)
Remotely mounted fuel, engine oil and case drain filters for maximum convenience while servicing

Carrier

Heavy duty carrier frame with two speed powershift transmission
Heavy duty drive line and axles / Front axle oscillation +/- 7 degrees with ram lock
Wet disc brake (front & rear) / Automatic parking brake - spring applied, hydraulically released

Improved Steering Column

Slim-profile steering column capable of telescoping 60 mm and tilting 30 degrees

Enhanced Operator Cab

Improved visibility

Enlarged cab with improved visibility
Larger right-side glass, now one piece, for better right visibility
Safety glass windows on all sides - less expensive than (polycarbonate) and won't scratch or fade
Reduced front window seam for improved operator view

Improved Cab Construction

New steel tube construction for added operator safety, protection and durability
New window open/close mechanism designed with cable and spring lift assist and single latch release

Improved Suspension Seat / Console Assembly

Ergonomic joysticks with auxiliary control buttons for attachment use, now with new sleek styling
Adjustable arm rests - turn dial to raise or lower for optimum comfort

Advanced 7" Color Cluster

New Color LCD Display with easy to read digital gauges for hydraulic oil temperature, water temperature, and fuel / Simplified design makes adjustment and diagnostics easier. Also, new enhanced features such as rear-view camera are integrated into monitor.

3 power modes : (P) Power, (S) Standard, (E) Economy

2 work modes : Dig & Attachment, (U) User mode for operator preference

Enhanced self-diagnostic features with GPS / satellite technology

One pump flow or two pump flow for optional attachment is now selectable through the cluster.

New anti-theft system with password capability

Boom speed and arm regeneration are selectable through the monitor.

Auto power boost is now available - selectable (on/off) through the monitor.

Powerful air conditioning and heat with auto climate control, 20% more heat and air output than 7 series!

Hi-Mate (Remote Management System) works through GPS/Satellite technology to ultimately provide better customer service and support



*Photo may include optional equipment.

Preference

Operating a 9S Series is unique to every operator. Operators can fully customize their work environment and operating preferences to fit their individual needs.



*Photo may include optional equipment.



Wide Cabin with Excellent Visibility

The newly designed cabin was conceived for more space, a wider field of view and operator comfort. Special attention was given to a clear, open and convenient interior with plenty of visibility on the machine surroundings and the job at hand. This well balanced combination of precision aspects put the operator in the perfect position to work safely and securely.

Operator Comfort

In 9S Series cabin you can easily adjust the seat, console and armrest settings to best suit your personal operating preferences. Seat and console position can be set together and independent from each other. Improved steering wheel telescope and tilt functions provide operators improved access. A fully automatic, high capacity airconditioning system maintains a constant preferred temperature.



Reduced Stress

Work is stressful enough. Your work environment should be stress free. Hyundai's 9S series provides improved cab amenities, additional space and a comfortable seat to minimize stress to the operator. A powerful climate control system provides the operator with optimum air temperature. An advanced audio system with USB player, AM/FM stereo is perfect for listening to music favorites.



Operator - Friendly Cluster

The advanced new cluster with 7 inch wide color LCD screen and toggle switch allows the operator to select his personal machine preferences. Power and work mode selection, self diagnostics, optional rear-view camera, maintenance check lists, start-up machine security, and video functions were integrated into the cluster to make the machine more versatile and the operator more productive.



Precision

Innovative hydraulic system technologies make the 9S Series excavator fast, smooth and easy to control.



*Photo may include optional equipment.

Computer Aided Power

The engine horsepower and hydraulic horsepower together in unison through the advanced CAPO(Computer Aided Power Optimization) system, flow for the job at hand. Operator can set their own preferences for boom or swing priority, power mode selection and optional work tools at the touch of a button.

The CAPO system also provides complete self diagnostic features and digital gauges for important information like hydraulic oil temperature, water temperatures and fuel level. This system interfaces with multiple sensors placed throughout the hydraulic system as well as hydraulic flow.

- Power Mode** P (Power Max) mode maximizes machine speed and power for mass production. S (Standard) mode provides a reduced, fixed rpm for optimum performance and improved fuel economy. For maximum fuel savings and improved control, E (Economy) mode provides precise flow based on load demand. Three unique power modes provide the operator with custom power, speed and fuel economy.
- Work Mode** The work mode allows the operator to select single flow attachments like a hydraulic breaker or bi-directional flow attachments like a crusher. Flow settings unique to each attachment can be programmed from within the cluster.
- User Mode** Some jobs require more precise machine settings. Using the versatile U (User) mode, the operator can customize engine speed, pump output, idle speed and other machine settings for the job at hand.

Improved Hydraulic System



To achieve optimum precision, Hyundai redesigned the hydraulic system to provide the operator with super fine touch and improved controllability. Improved pump flow control reduces flow when controls are not being used to minimize fuel consumption.

Improved spool valves in the control valve are engineered to provide more precise flow to each function with less effort.

Improved hydraulic valves, precision-designed variable volume piston pumps, fine-touch pilot controls, and enhanced travel functions make any operator running a 9S Series look like a smooth operator. Newly improved features

include arm-in and boom-down flow regeneration, improved control valve technology and innovative auto boom and swing priority for optimal performance in any application.



Auto Boom-swing Priority

This smart function automatically and continuously looks the ideal hydraulic flow balance for the boom and swing motions of the machine. The advanced CAPO system monitors the hydraulic system and adjusts its settings to maximize performance and productivity.

Performance

9S Series is designed for maximum performance to keep the operator working productively.



*Photo may include optional equipment.

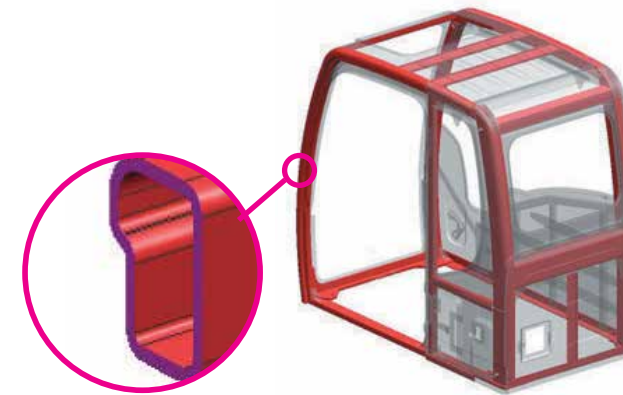

Structural Strength

The 9S series cabin structure has been fitted with stronger but slimmer tubing for more safety and better visibility. Low-stress and high strength steel was integrally welded to form a strong and stable lower frame. Structural durability was evaluated and tested by means of FEM (Finite Elements Method) analysis and long-term durability tests.



Improved Durability

9S series excavators are equipped with stainless spring guards to protect the hoses from external damages. Both dozer and outrigger are equipped with cylinder guards for added protection.

New Auto Ram Lock System

During not traveling in work-mode, a new auto ram lock system is available to improve operating safety.



CUMMINS B3.9C ENGINE

The Cummins B3.9-C engine has been designed with 40% fewer parts than the competitors. That means there's less that can go wrong when you need it most. It also means fewer parts to inventory. Repairs are simplified because no special tools are needed for maintenance. The weight of the machine is reduced without sacrificing strength.

The B3.9-C engine is capable of reaching emission standards without electronic engine controls. You get a proven power plant that meets ecological concerns, without paying a premium for technology you don't need.

Profitability

9S Series is designed to maximize profitability through improved efficiencies, enhanced service features and longer life components.



*Photo may include optional equipment.

Fuel Efficiency

9S Series excavators are engineered to be extremely fuel efficient. New innovations like two-stage auto decel system and the new economy mode help to conserve fuel and reduce the impact on the environment.



Hi-MATE (Remote Management System)

Hi-MATE, Hyundai's proprietary remote management system, provides operators and dealer service personnel access to vital service and diagnostic information on the machine from any computer with internet access. Users can pinpoint machine location using digital mapping and set machine work boundaries, reducing the need for multiple service calls. Hi-MATE saves time and money for the owner and dealer by promoting preventative maintenance and reducing machine downtime.



Easy Access

Ground-line access to filters, lube fittings, fuses, machine computer components and wide open compartments makes service more convenient on the 9S Series.



Long-Life Components

9S series excavators were designed with bushings designed for long-life lube intervals (250 hrs) & polymer shims (wear resistant, noise reducing), long-life hydraulic filters (1,000hrs), long-life hydraulic oil (5,000hrs), more efficient cooling systems and integrated preheating systems which extend service intervals, minimize operating costs and reduce machine down time.

Specifications

ENGINE

MODEL		Cummins B3.9-C	
Type		Water cooled, 4 cycle diesel, 4-cylinders in line, direct injection, turbocharged, charger air cooled, low emission	
Rated flywheel horsepower	SAE	J1995 (gross)	113 HP (84 kW) at 2100 rpm
		J1349 (net)	105 HP (78 kW) at 2100 rpm
Rated flywheel horsepower	DIN	6271/1 (gross)	115 PS (84 kW) at 2100 rpm
		6271/1 (net)	106 PS (78 kW) at 2100 rpm
Max. torque	45.6 kgf·m (330lb-ft) / 1,500 rpm		
Bore X stroke	102 mm X 120 mm (4.02" X 4.72")		
Piston displacement	3,900cc (238 in ³)		
Batteries	2 x 12 V x 100 AH		
Starting motor	24V, 4.5 kW		
Alternator	24V, 70 Amp		

HYDRAULIC SYSTEM

MAIN PUMP	
Type	Two variable displacement piston pumps
Rated flow	2 X 130 L/min (34.3 US gpm/28.6 UK gpm)
Sub-pump for pilot circuit	Gear pump

Cross-sensing and fuel saving pump system

HYDRAULIC MOTORS

Travel	Axial piston motor with brake valve
Swing	Axial piston motor with automatic brake

RELIEF VALVE SETTING

Implement circuits	350 kgf/cm ² (4,970 psi)
Travel	380 kgf/cm ² (5,400 psi)
Power boost (boom, arm, bucket)	380 kgf/cm ² (5,400 psi)
Swing circuit	285 kgf/cm ² (4,050 psi)
Pilot circuit	40 kgf/cm ² (570 psi)
Service valve	Installed

HYDRAULIC CYLINDERS

No. of cylinder bore X stroke	Boom : 2-105 x 1,075 mm (4.1" x 42.3")
	Arm : 1-115 x 1,138 mm (4.5" x 46.8")
	Bucket : 1-100 x 840 mm (3.9" x 33.1")
	Blade : 2-100 x 236 mm (3.9" x 9.3")
	Outrigger : 2-110 x 446 mm (4.3" x 7.6")

DRIVES & BRAKES

4-wheel hydrostatic drive. Constant mesh, helical gear transmission provides 2 forward and reverse travel speeds.

Max. drawbar pull	8,500 kgf (18,740 lbf)	
travel speed	1st	8 km/h (5.0 mph)
	2nd	30 km/h (18.6 mph)
Gradeability	35° (70 %)	
Parking brake : Independent dual brake, front and rear axle full hydraulic power brake. - Spring released and hydraulic applied wet type multiple disk brake. - Transmission is locked at neutral position for parking, automatically.		

CONTROL

Pilot pressure operated joysticks and pedals with detachable lever provide almost effortless and fatigueless operation.

Pilot control	Two joysticks with one safety lever (LH): Swing and arm, (RH): Boom and bucket (ISO)
Engine throttle	Electric, Dial type

AXLE & WHEEL

Full floating front axle is supported by center pin for ocillation. It can be locked by ocillation lock cylinders. Rear axle is fixed on the lower chassis.

Tires	9.00-20-14PR, Dual(tube type)
(optional)	9.00-20, Dual(solid type)

SWING SYSTEM

Swing motor	Axial pistons motor
Swing reduction	Planetary gear reduction
Swing bearing lubrication	Grease-bathed
Swing brake	Multi wet disc(pin lock type)
Swing speed	12.9 rpm

STEERING SYSTEM

Hydraulically actuated, orbitrol type steering system actuates on front wheels through the steering cylinders.

Min. turning radius	6,300 mm(20' 8")
---------------------	------------------

COOLANT & LUBRICANT CAPACITY

	liter	US gal	UK gal
Refilling			
Fuel tank	270.0	71.3	59.4
Engine coolant	17.5	4.6	3.8
Engine oil	15.3	4.0	3.4
Swing device - gear oil	2.5	0.7	0.5
Axle	Front	13.8	3.6
	Rear	16.0	4.2
Hydraulic system (including tank)	210.0	55.5	46.2
Hydraulic tank	124.0	32.8	27.3

UNDERCARRIAGE

Reinforced box-section frame is all-welded, low-stress. Dozer blade and outriggers are available. A pin-on design.

Dozer blade	A very useful addition for leveling and back filling or clean-up work.
Outrigger	Indicated for max. operation stability when digging and lifting. Can be mounted on the front/or the rear.

OPERATING WEIGHT (APPROXIMATE)

Operating weight, including 4,600mm (15' 1") One-piece boom, 2,100mm (6' 11") arm, SAE heaped 0.58 m³ (0.76 yd³) backhoe bucket, lubricant, coolant, full fuel tank, hydraulic tank and the standard equipment.

MAJOR COMPONENT WEIGHT	
Upperstructure	4,680kg (10,320 lb)
Mono boom(with arm cylinder)	1,030kg (2,270 lb)

OPERATING WEIGHT	
Undercarriage	Mono boom
Rear dozer blade	13,700kg (30,200 lb)
Rear outrigger	14,100kg (31,090 lb)
Front outrigger and rear blade	14,700kg (32,410 lb)
Front blade and rear outrigger	14,700kg (32,410 lb)
Four outrigger	15,100kg (33,290 lb)

AIR CONDITIONING SYSTEM

The air condition system for the machine contains the fluorinated greenhouse gas with global warming potential of R134a. (Global Warming Potential : 1430) The system hold 0.75kg refrigerant consisting of a CO₂ equivalent 1.07kg metric tonne. For more information, Please refer to the manual.

BUCKETS

All buckets are welded with high-strength steel.



0.23 (0.30)



0.40 (0.52)
0.46 (0.60)



0.52 (0.68)
0.58 (0.76)



0.65 (0.85)



0.71 (0.93)

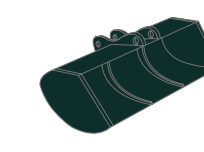

0.45 (0.59)

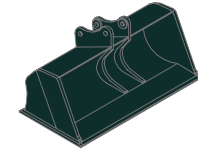

0.55 (0.72)

SAE heaped m³ (yd³)

SAE heaped	CECE heaped	Width mm (in)		Weight kg (lb)	Recommendation mm (ft-in)			
		Without sidecutters	With sidecutters		4.6 (15' 1") Boom			
					1.9 (6' 3") Arm	2.1 (6' 11") Arm	2.5 (8' 2") Arm	3.0 (9' 10") Arm
0.23 (0.30)	0.20(0.26)	520(20.5)	620(24.4)	335(740)	●	●	●	●
0.40 (0.52)	0.35(0.46)	750(29.5)	850(33.5)	410(900)	●	●	●	●
0.46 (0.60)	0.40(0.52)	840(33.1)	940(37.0)	435(960)	●	●	●	■
0.52 (0.68)	0.45(0.59)	915(36.0)	1,015(40.0)	460(1,010)	●	●	■	▲
0.58 (0.76)	0.50(0.65)	1,000(39.4)	1,100(43.3)	480(1,060)	●	■	■	▲
0.65 (0.85)	0.55(0.72)	1,105(43.5)	1,205(47.4)	500(1,100)	■	▲	▲	-
0.71 (0.93)	0.60(0.78)	1,190(46.9)	1,290(50.8)	540(1,190)	▲	▲	-	-
0.45 (0.59)	0.40(0.52)	1,520(59.8)	1,620(63.8)	410(900)	●	●	■	-
0.55 (0.72)	0.45(0.59)	1,800(70.9)	1,900(74.8)	585(1,290)	■	▲	▲	-

■ Ditching bucket

○ Heavy duty bucket

●: Applicable for materials with density of 2,000 kg /m³ (3,370 lb/ yd³) or less

■: Applicable for materials with density of 1,600 kg /m³ (2,700 lb/ yd³) or less

▲: Applicable for materials with density of 1,100 kg /m³ (1,850 lb/ yd³) or less

ATTACHMENT

Booms and arms are welded with a low-stress, full-box section design. 4.6m (15' 1") Boom and 1.9m (6' 3"), 2.1m (6' 11"), 2.5m (8' 2"), & 3.0m (9' 10") Arms are available.

DIGGING FORCE

Boom	Length	mm (ft-in)	4,600 (15' 1")				Remarks
	Weight	kg (lb)	1,030 (2,270)				
Arm	Length	mm (ft-in)	1,900 (6' 3")	2,100 (6' 11")	2,500 (8' 2")	3,000 (9' 10")	Power Boost
	Weight	kg (lb)	560 (1,230)	580 (1,280)	610 (1,340)	670 (1,480)	
Bucket digging force	SAE	kN	87.3 [94.8]	87.3 [94.8]	87.3 [94.8]	87.3[94.8]	[]: Power Boost
		kgf	8,900 [9,660]	8,900 [9,660]	8,900 [9,660]	8,900[9,660]	
		lbf	19,620 [21,300]	19,620 [21,300]	19,620 [21,300]	19,620[21,300]	
	ISO	kN	102 [110.8]	102 [110.8]	102 [110.8]	102[110.8]	
		kgf	10,400 [11,290]	10,400 [11,290]	10,400 [11,290]	10,400[11,290]	
		lbf	22,930 [24,890]	22,930 [24,890]	22,930 [24,890]	22,930[24,890]	
Arm crowd force	SAE	kN	76.5 [83.1]	73.6 [79.9]	62.8 [68.2]	55.9[60.7]	
		kgf	7,800 [8,470]	7,500 [8,140]	6,400[6,950]	5,700[6,190]	
		lbf	17,200 [18,670]	16,530 [17,950]	14,110[15,320]	12,570[13,640]	
	ISO	kN	80.4 [87.3]	77.5 [84.1]	65.7[71.4]	57.9[62.8]	
		kgf	8,200 [8,900]	7,900 [8,580]	6,700[7,270]	5,900[6,410]	
		lbf	18,080 [19,630]	17,420 [18,910]	14,770[16,040]	13,010[14,120]	

Note : Boom weight includes arm cylinder, piping, and pin

Arm weight includes bucket cylinder, linkage, and pin

Dimensions & Working Range

R140W-9S DIMENSIONS

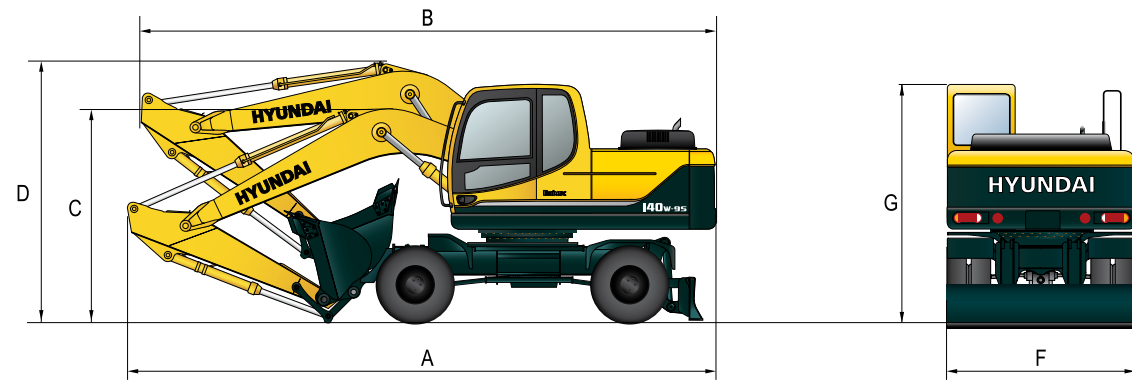

Unit : mm (ft-in)

	4,600(15' 1")			
Mono Boom				
Arm	1,900 (6' 3")	2,100 (6' 11")	2,500 (8' 2")	3,000 (9' 10")
A Overall length of shipping position	7,760 (25' 6")	7,820 (25' 8")	7,770 (25' 6")	7,830 (25' 8")
B Overall length of traveling position	7,750 (25' 5")	7,760 (25' 6")	7,690 (25' 3")	7,710 (25' 4")
C Height of attachment(shipping position)	2,760 (9' 1")	2,860 (9' 5")	2,810 (9' 3")	3,100 (10' 2")
D Height of attachment(traveling position)	3,500 (11' 6")	3,500 (11' 6")	3,620 (11' 11")	3,600 (11' 10")
F Overall width	2,500 (8' 2")	2,500 (8' 2")	2,500 (8' 2")	2,500 (8' 2")
G Height of cabin	3,140 (10' 4")	3,140 (10' 4")	3,140 (10' 4")	3,140 (10' 4")

R140W-9S WORKING RANGE

Unit : mm (ft-in)

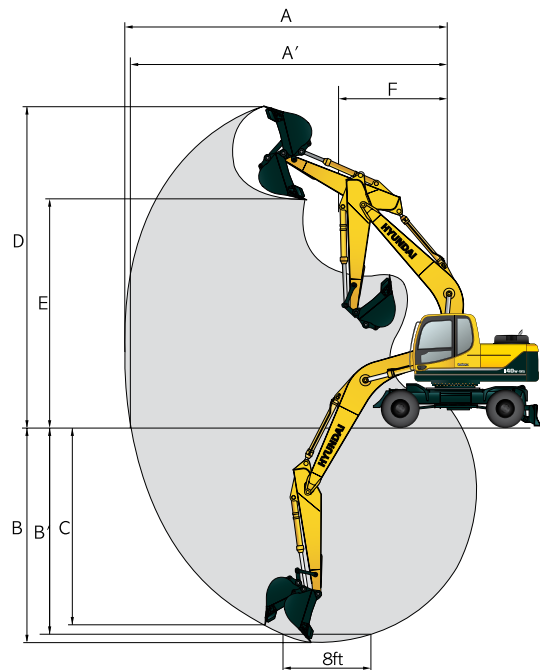

	4,600 (15' 1")			
Boom length				
Arm length	1,900 (6' 3")	2,100 (6' 11")	2,500 (8' 2")	3,000 (9' 10")
A Max. digging reach	7,750 (25' 5")	7,920 (26' 0")	8,320 (27' 4")	8,790 (28' 10")
A' Max. digging reach on ground	7,530 (24' 8")	7,700 (25' 3")	8,120 (26' 8")	8,590 (28' 2")
B Max. digging depth	4,650 (15' 3")	4,850 (15' 11")	5,250 (17' 3")	5,750 (18' 10")
B' Max. digging depth (8' level)	4,390 (14' 5")	4,600 (15' 1")	5,040 (16' 6")	5,570 (18' 3")
C Max. vertical wall digging depth	4,350 (14' 3")	4,460 (14' 8")	5,030 (16' 6")	5,550 (18' 3")
D Max. digging height	8,400 (27' 7")	8,470 (27' 9")	8,790 (28' 10")	9,070 (29' 9")
E Max. dumping height	5,960 (19' 7")	6,040 (19' 10")	6,350 (20' 10")	6,620 (21' 9")
F Min. swing radius	2,620 (8' 7")	2,670 (8' 10")	2,650 (8' 8")	2,670 (8' 9")

Undercarriage

R140W-9S WITH REAR DOZER

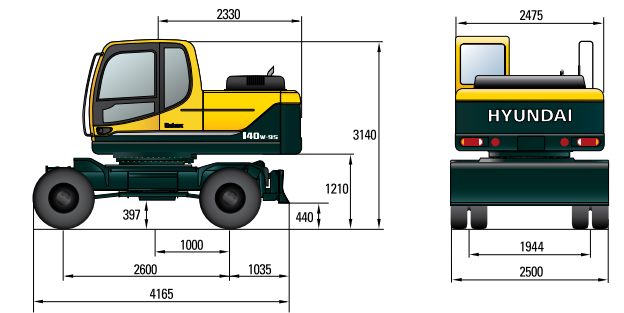

R140W-9S WITH REAR OUTRIGGER

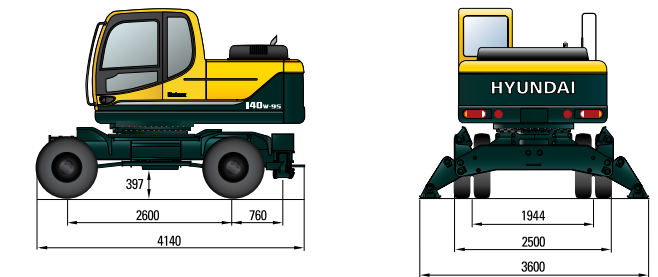

R140W-9S WITH REAR DOZER AND FRONT OUTRIGGER

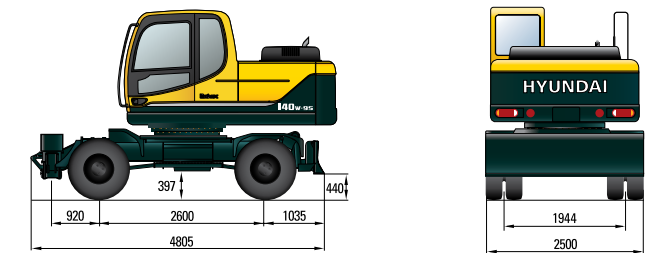

R140W-9S WITH REAR AND FRONT OUTRIGGER

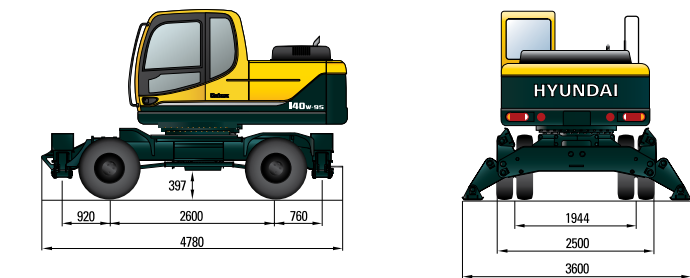

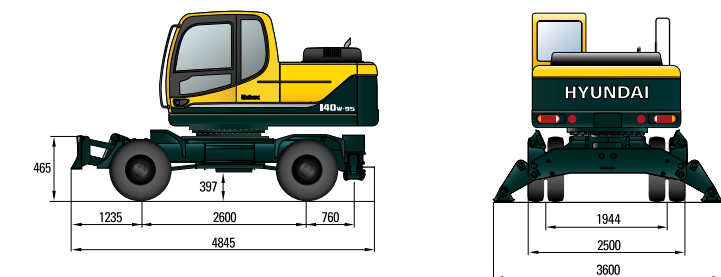

R140W-9S WITH REAR OUTRIGGER AND FRONT DOZER













Lifting Capacity

R140W-9S MONO BOOM

 Rating over-front  Rating over-side or 360 degree

Boom : 4.6 m (15' 1") / Arm : 1.9 m (6' 3") / Bucket : 0.58 m³ (0.76 yd³) SAE heaped / With rear dozer blade down











Load point height m (ft)		Load radius								At max. reach		
		1.5 m (5 ft)		3.0 m (10 ft)		4.5 m (15 ft)		6.0 m (20 ft)		Capacity		Reach
												m (ft)
6.0 m (20 ft)	kg lb					*3350 *7390	*3350 *7390			*3200 *7050	2080 4590	6.22 (20.4)
4.5 m (15 ft)	kg lb					*3740 *8250	3550 7830	*2860 *6310	2120 4670	*3310 *7300	1610 3550	7.05 (23.1)
3.0m (10 ft)	kg lb			*7070 *15590	6400 14110	*4710 *10380	3330 7340	*3900 *8600	2050 4520	3370 7430	1420 3130	7.42 (24.3)
1.5 m (5 ft)	kg lb			*7620 *16800	5740 12650	*5750 *12680	3090 6810	*4340 *9570	1960 4320	3320 7320	1380 3040	7.42 (24.3)
Ground Line	kg lb			*8960 *19750	5590 12320	*6340 *13980	2940 6480	*4600 *10140	1890 4170	3590 7910	1480 3260	7.06 (23.2)
-1.5 m (-5 ft)	kg lb	*7690 *16950	*7690 *16950	*9450 *20830	5620 12390	*6250 *13780	2920 6440			*3860 *8510	1830 4030	6.24 (20.5)
-3.0 m (-10 ft)	kg lb			*7750 *17090	5800 12790	*5020 *11070	3030 6680					

Lifting Capacity

R140W-9S MONO BOOM



 Rating over-front  Rating over-side or 360 degree

Boom : 4.6 m (15' 1") / Arm : 2.1 m (6' 11") / Bucket : 0.58 m³ (0.76 yd³) SAE heaped / With rear dozer blade down











Load point height m (ft)		Load radius								At max. reach		
		1.5 m (5 ft)		3.0 m (10 ft)		4.5 m (15 ft)		6.0 m (20 ft)		Capacity		Reach
												m (ft)
6.0 m (20 ft)	kg lb					*3130 *6900	*3130 *6900			*3050 *6720	1950 4300	6.43 (21.1)
4.5 m (15 ft)	kg lb					*3540 *7800	*3540 *7800	*3210 *7080	2120 4670	*3160 *6970	1520 3350	7.23 (23.7)
3.0m (10 ft)	kg lb			*6620 *14590	6450 14220	*4510 *9940	3310 7300	*3770 *8310	2040 4500	3230 7120	1340 2950	7.59 (24.9)
1.5 m (5 ft)	kg lb			*8650 *19070	5730 12630	*5580 *12300	3060 6750	*4230 *9330	1930 4250	3180 7010	1300 2870	7.59 (24.9)
Ground Line	kg lb			*9090 *20040	5510 12150	*6240 *13760	2900 6390	*4540 *10010	1860 4100	3420 7540	1390 3060	7.24 (23.8)
-1.5 m (-5 ft)	kg lb	*7380 *16270	*7380 *16270	*9530 *21010	5530 12190	*6240 *13760	2860 6310			*3760 *8290	1700 3750	6.45 (21.2)
-3.0 m (-10 ft)	kg lb	*11710 *25820	*11710 *25820	*7990 *17610	5690 12540	*5240 *11550	2950 6500					

Lifting Capacity

R140W-9S MONO BOOM

 Rating over-front  Rating over-side or 360 degree

Boom : 4.6 m (15' 1") / Arm : 2.5 m (8' 2") / Bucket : 0.58 m³ (0.76 yd³) SAE heaped / With rear dozer blade down

Load point height m (ft)	Load radius								At max. reach			
	1.5 m (5 ft)		3.0 m (10 ft)		4.5 m (15 ft)		6.0 m (20 ft)		Capacity		Reach	
											m (ft)	
6.0 m (20 ft)	kg								*2820	1700	6.92	
	lb								*6220	3750	(22.7)	
4.5 m (15 ft)	kg					*3110	*3110	*2980	2150	*2880	1360	7.66
	lb					*6860	*6860	*6570	4740	*6350	3000	(25.1)
3.0m (10 ft)	kg			*5700	*5700	*4110	3360	*3500	2050	*2930	1200	8.00
	lb			*12570	*12570	*9060	7410	*7720	4520	*6460	2650	(26.2)
1.5 m (5 ft)	kg			*8610	5850	*5270	3080	*4030	1930	2900	1160	8.00
	lb			*18980	12900	*11620	6790	*8880	4250	6390	2560	(26.2)
Ground	kg	*3820	*3820	*9000	5500	*6070	2890	*4430	1830	3090	1240	7.67
Line	lb	*8420	*8420	*19840	12130	*13380	6370	*9770	4030	6810	2730	(25.2)
-1.5 m (-5 ft)	kg	*6470	*6470	*9740	5460	*6260	2820	*4470	1800	*3510	1480	6.94
	lb	*14260	*14260	*21470	12040	*13800	6220	*9850	3970	*7740	3260	(22.8)
-3.0 m (-10 ft)	kg	*9750	*9750	*8560	5580	*5620	2870			*3480	2150	22.8
	lb	*21500	*21500	*18870	12300	*12390	6330			*7670	4740	(18.5)













- Lifting capacity is based on SAE J1097, ISO 10567.
- Lifting capacity of the Robex Series does not exceed 75% of the tipping load with the machine on firm, level ground or 87% of full hydraulic capacity.
- The load point is a hook located on the back of the bucket.
- (*) indicates the load limited by hydraulic capacity.

Lifting Capacity

R140W-9S MONO BOOM

 Rating over-front  Rating over-side or 360 degree

Boom : 4.6 m (15' 1") / Arm : 3.0 m (9' 10") / Bucket : 0.58 m³ (0.76 yd³) SAE heaped / With rear dozer blade down

Load point height m (ft)	Load radius										At max. reach					
	1.5 m (5 ft)		3.0 m (10 ft)		4.5 m (15 ft)		6.0 m (20 ft)		7.5 m (25 ft)		Capacity		Reach			
													m (ft)			
6.0 m (20 ft)	kg									*2100	*2100			*2570	1480	7.46
	lb									*4630	*4630			*5670	3260	(24.5)
4.5 m (15 ft)	kg									*2710	2200			*2590	1210	8.14
	lb									*5970	4850			*5710	2670	(26.7)
3.0m (10 ft)	kg							*3580	3450	*3170	2090	*1780	1350	*2640	1080	8.46
	lb							*7890	7610	*6990	4610	*3920	2980	*5820	2380	(27.8)
1.5 m (5 ft)	kg							*7700	6080	*4840	3150	*3770	1960	*2190	1290	8.46
	lb							*16980	13400	*10670	6940	*8310	4320	*4830	2840	(27.8)
Ground	kg	*3780	*3780	*9530	5580	*5830	2920	*4280	1840	*1820	1250	2780	1100	2780	1100	8.15
Line	lb	*8330	*8330	*21010	12300	*12850	6440	*9440	4060	*4010	2760	6130	2430	6130	2430	(26.7)
-1.5 m (-5 ft)	kg	*5830	*5830	*9890	5450	*6250	2810	*4490	1780			3210	1280	3210	1280	7.48
	lb	*12850	*12850	*21800	12020	*13780	6190	*9900	3920			7080	2820	7080	2820	(24.5)
-3.0 m (-10 ft)	kg	*8470	*8470	*9150	5500	*5950	2820	*3320	1810			*3390	1750	*3390	1750	6.31
	lb	*18670	*18670	*20170	12130	*13120	6220	*7320	3990			*7470	3860	*7470	3860	(20.7)
-4.5 m (-15 ft)	kg							*6890	5740							
	lb							*15190	12650							

- Lifting capacity is based on SAE J1097, ISO 10567.
- Lifting capacity of the Robex Series does not exceed 75% of the tipping load with the machine on firm, level ground or 87% of full hydraulic capacity.
- The load point is a hook located on the back of the bucket.
- (*) indicates the load limited by hydraulic capacity.